

HT20100

**MOTIVATE
YOUR LIFE !**

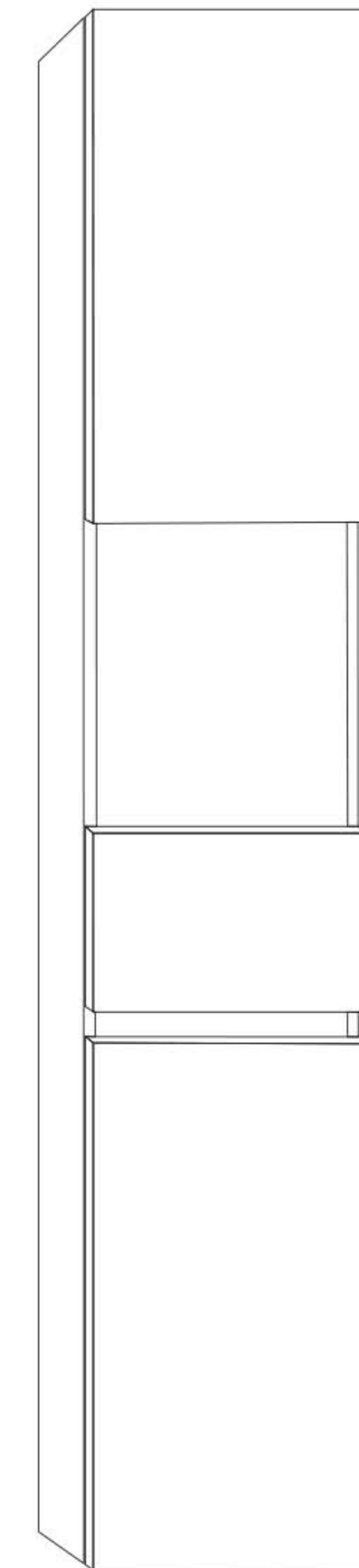

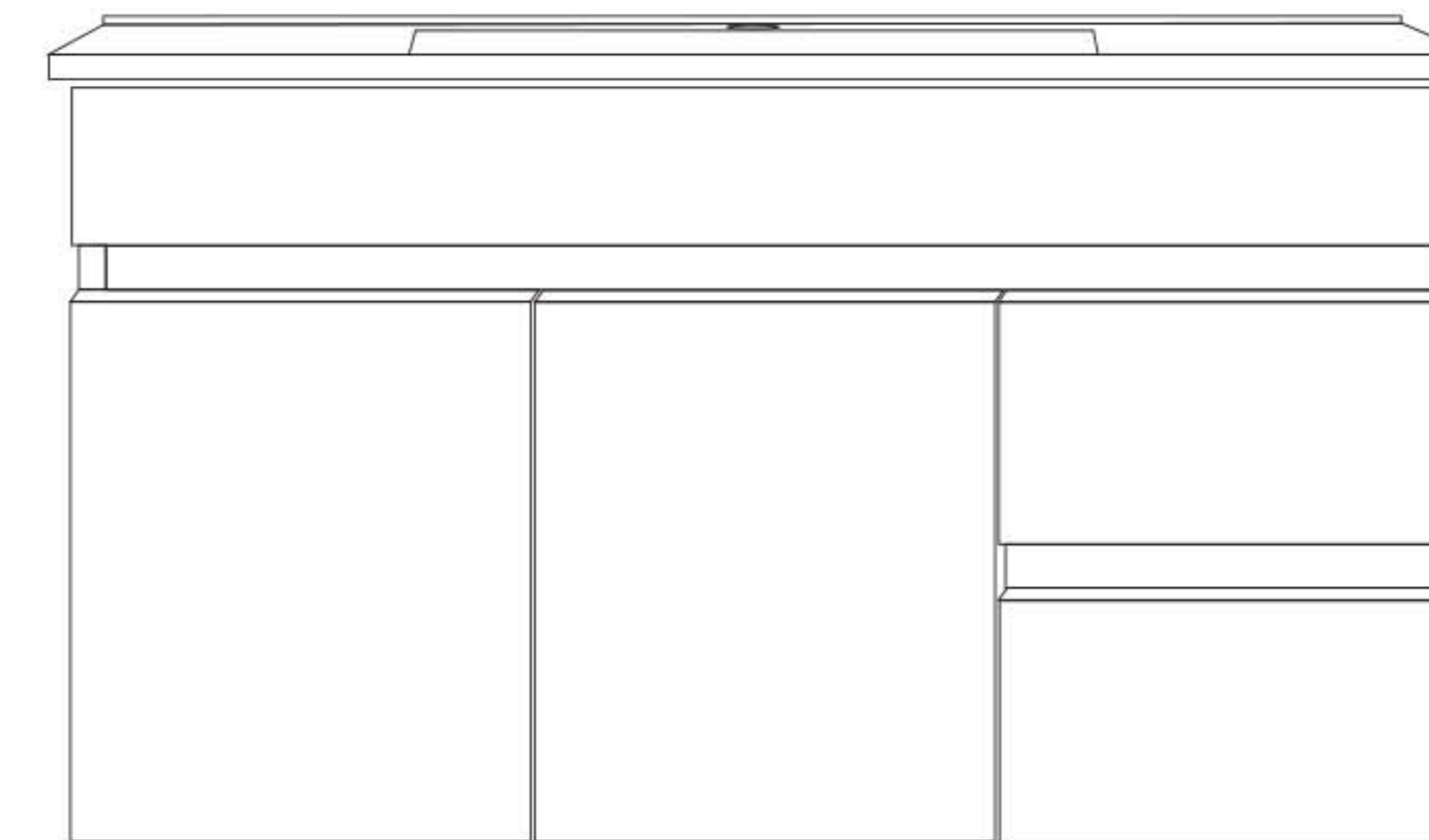

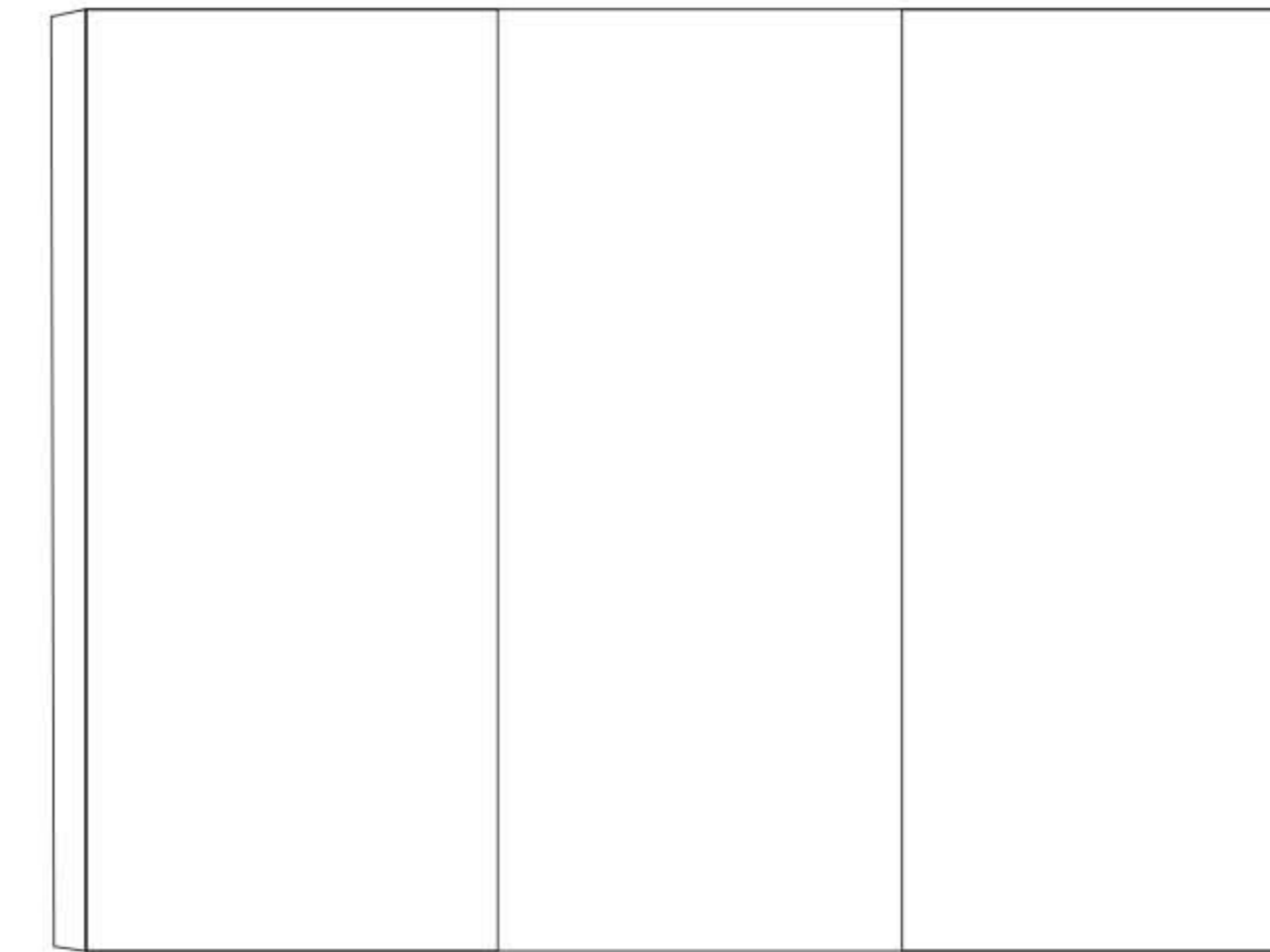

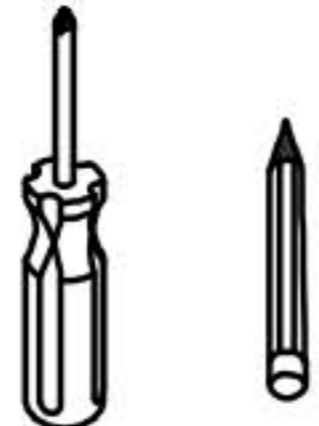

THANKS FOR WATCHING

Your feedback is invaluable to us and we would love to hear about your experience. Please take the time to leave us a review.

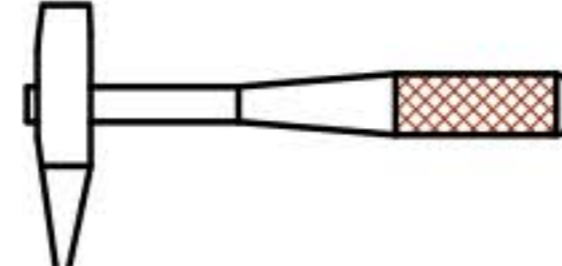
Thank you for shopping with us!

We encourage you to take a few minutes to go through this booklet. It contains important information on installation and care tips to keep your furniture looking as good as new.

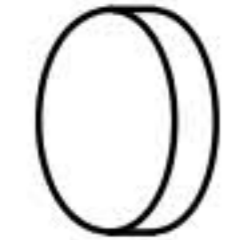

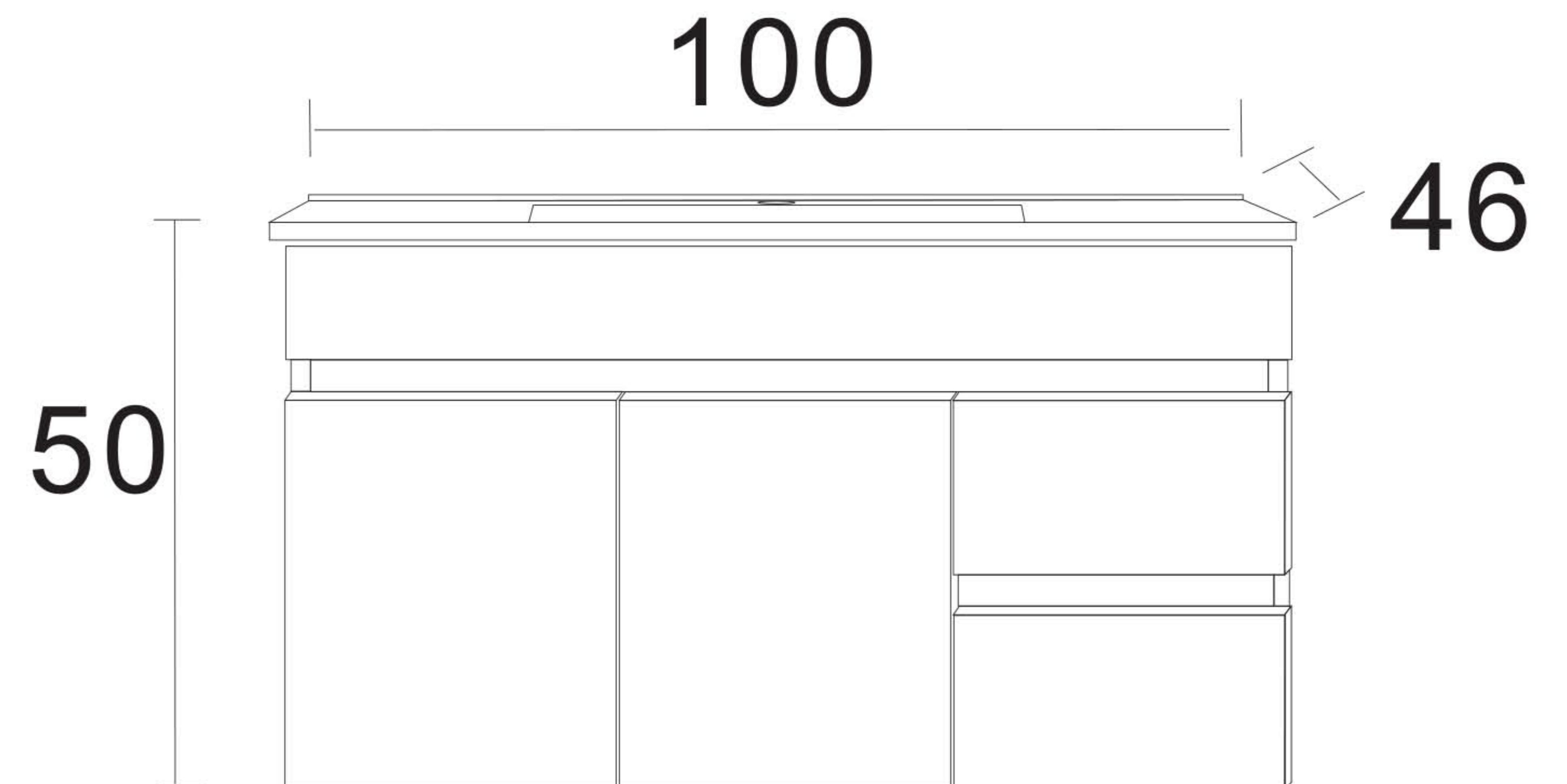





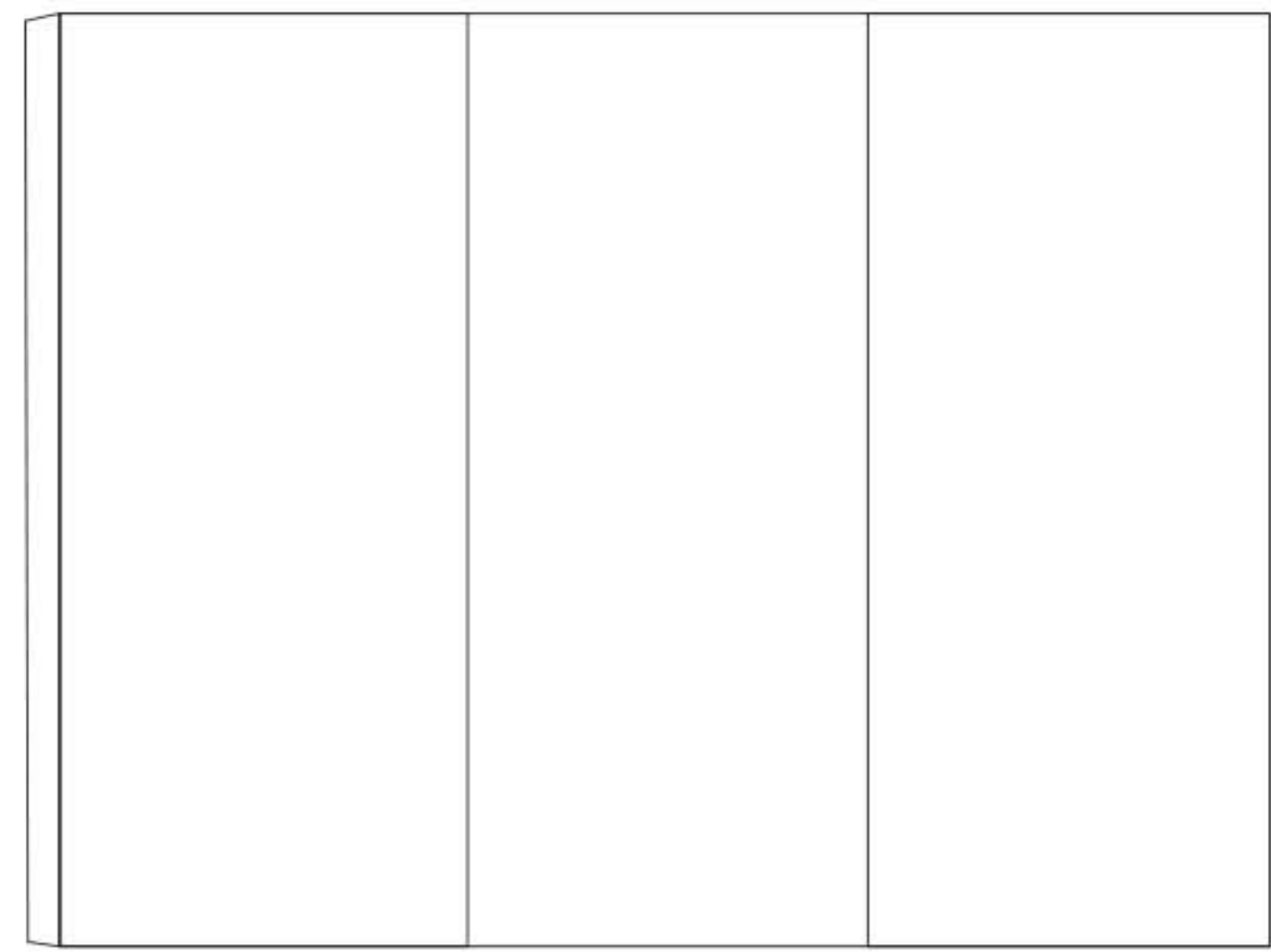



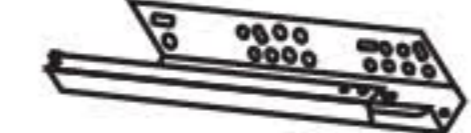

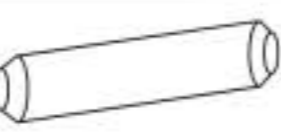



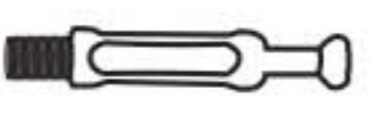

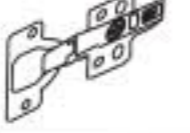

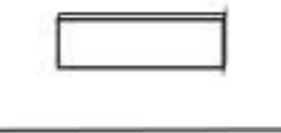
Hardware			Tools
NO.	Draw	QTY	
A		6	   
B		6	
C		4	
D		4	

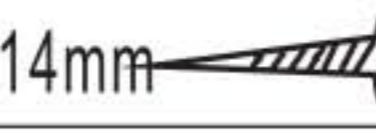

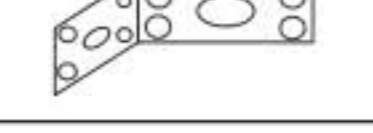
CARE CLEANING AND MAINTENANCE







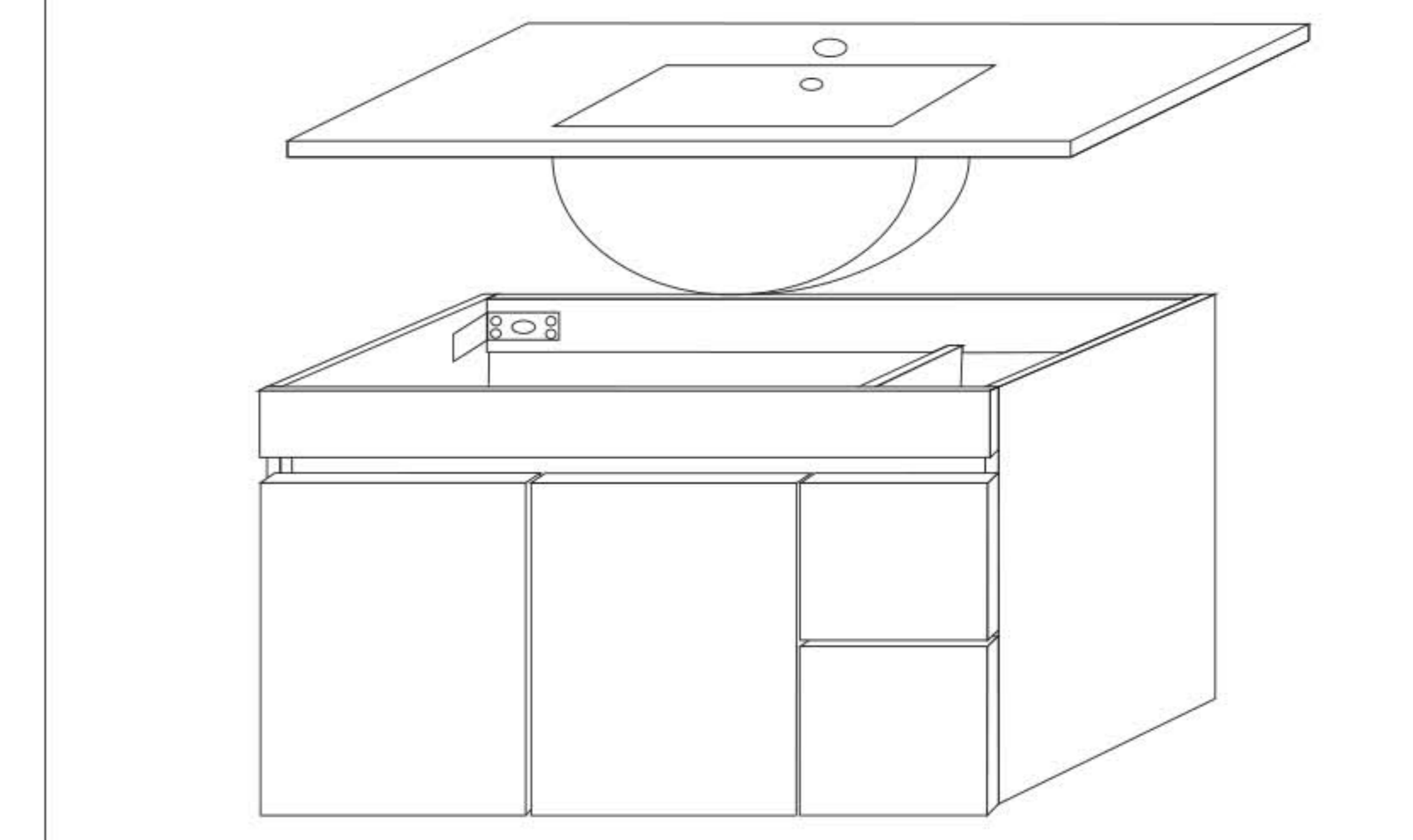
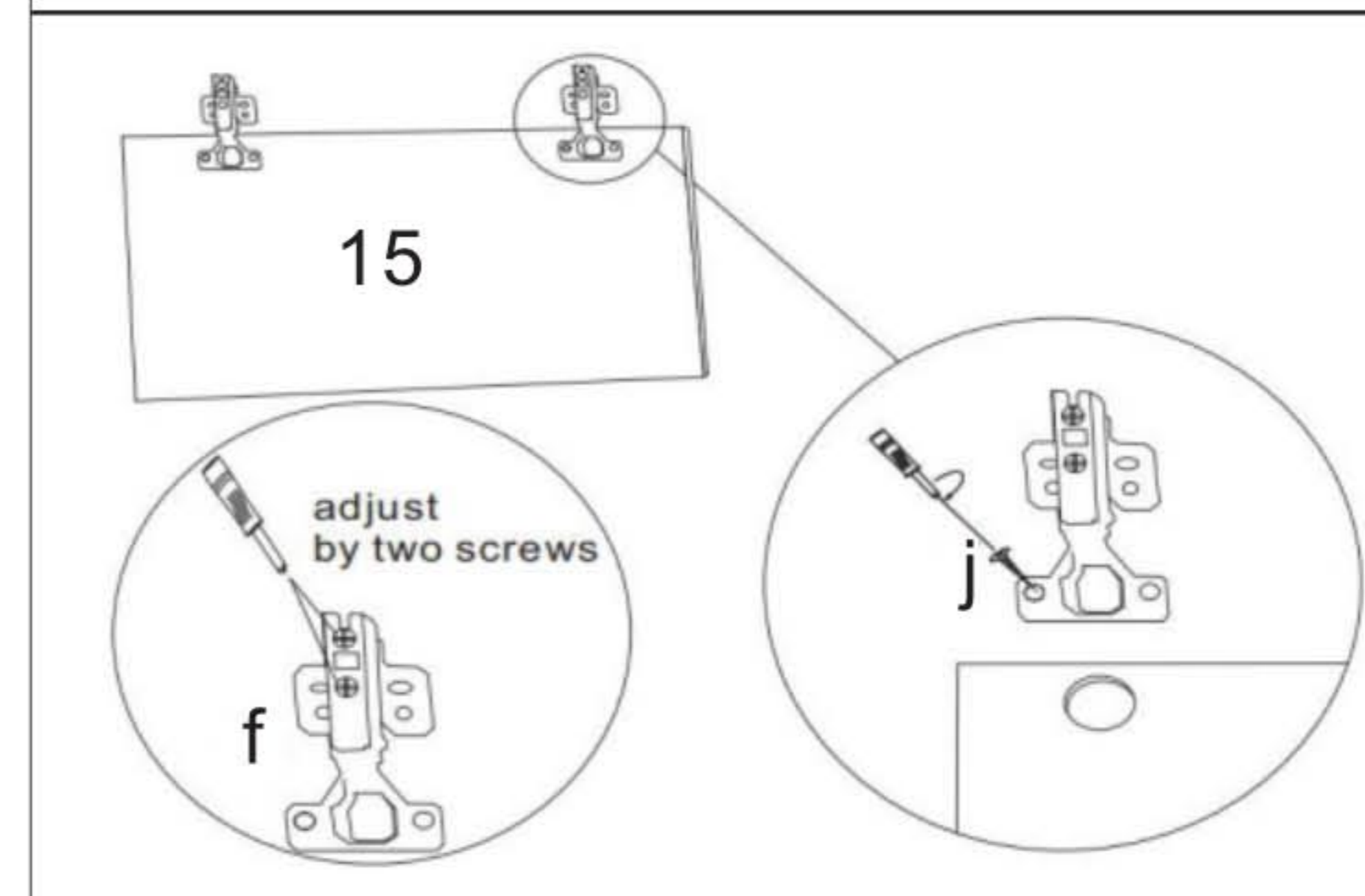
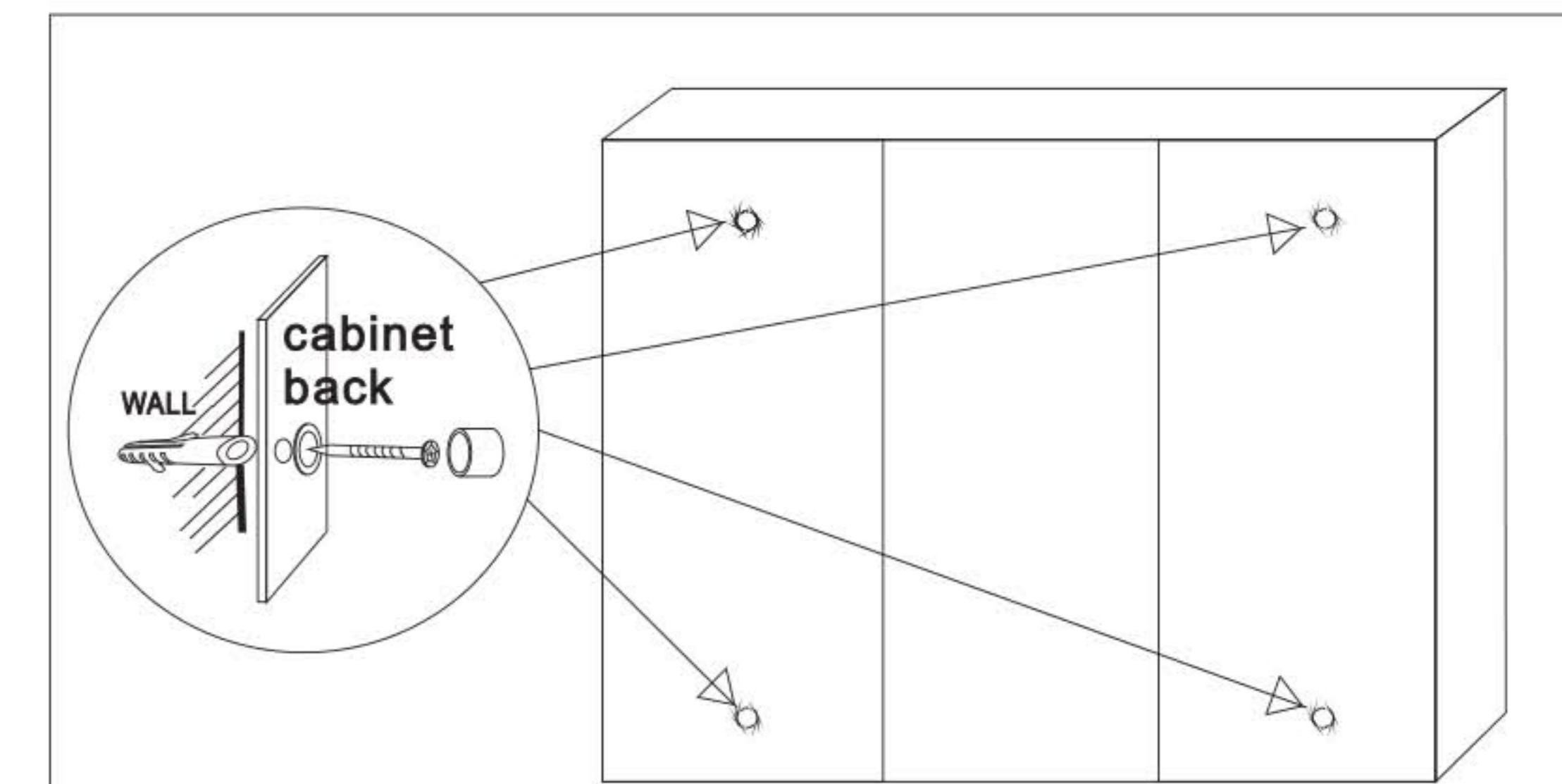
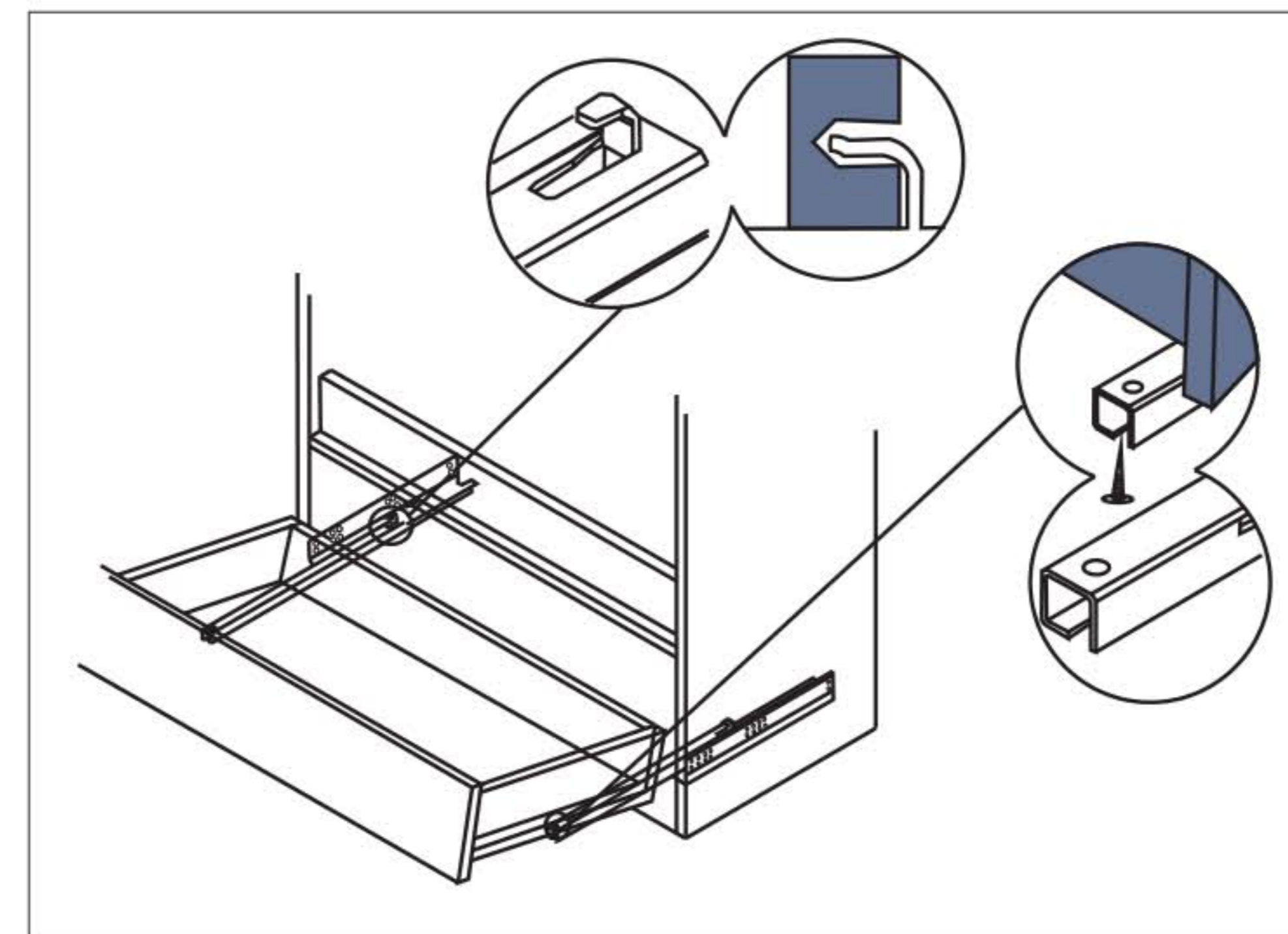
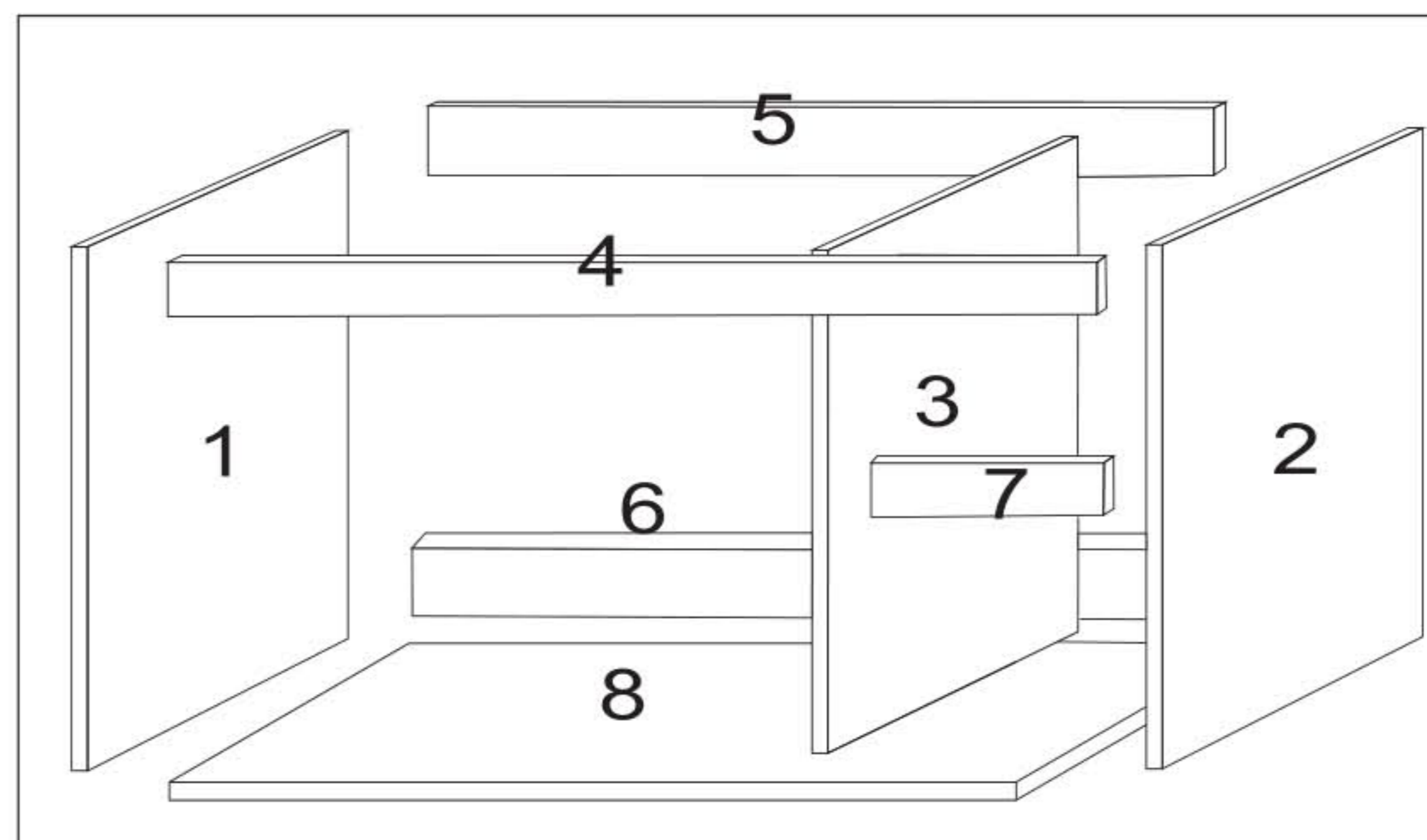
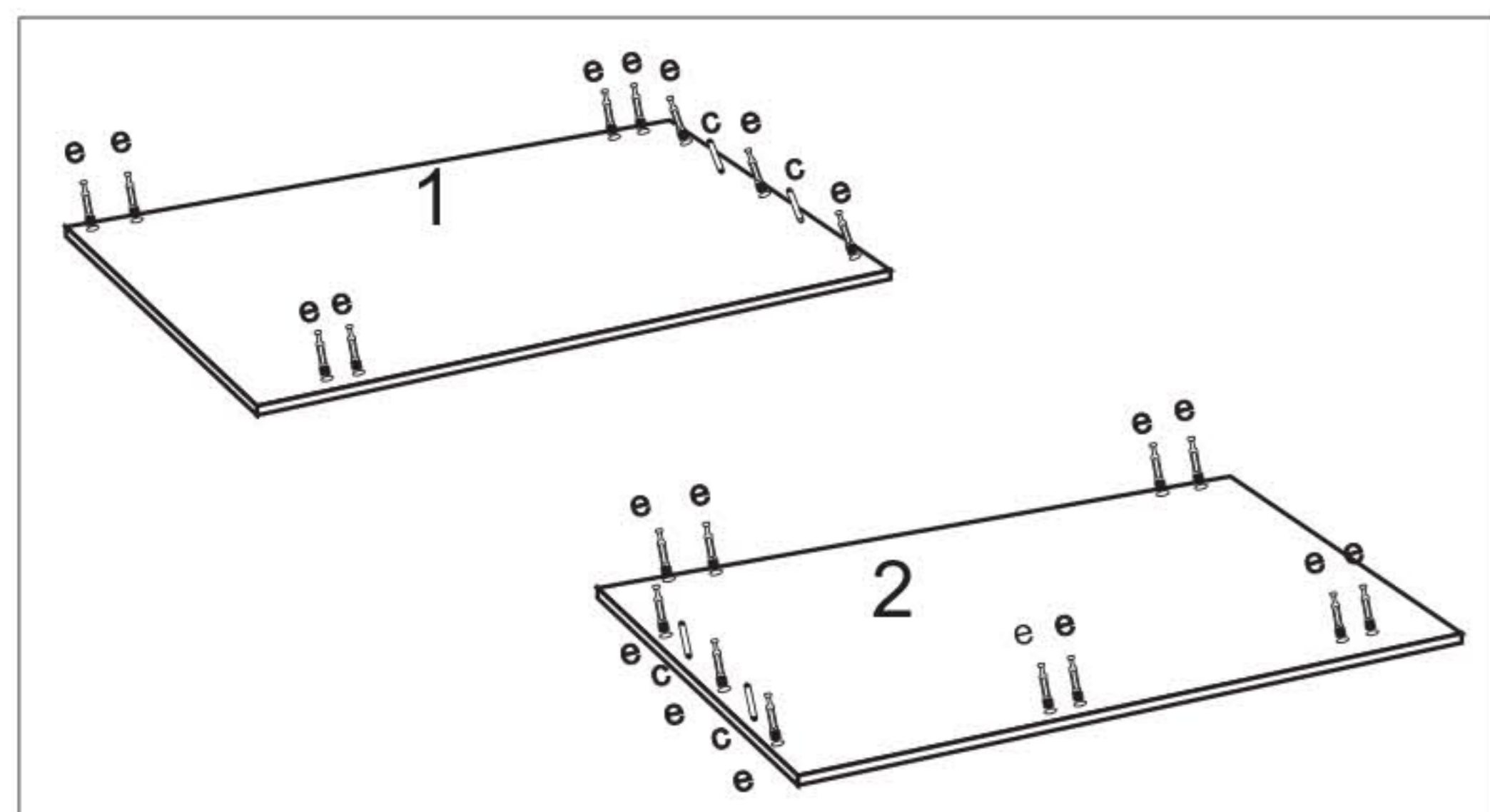
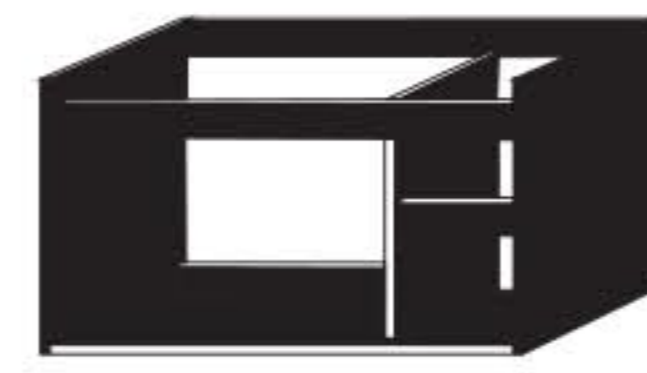
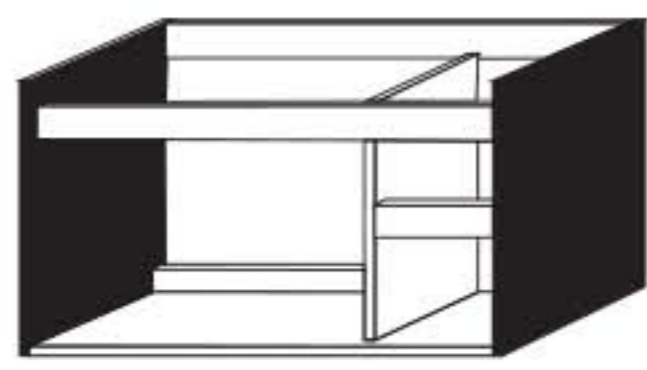
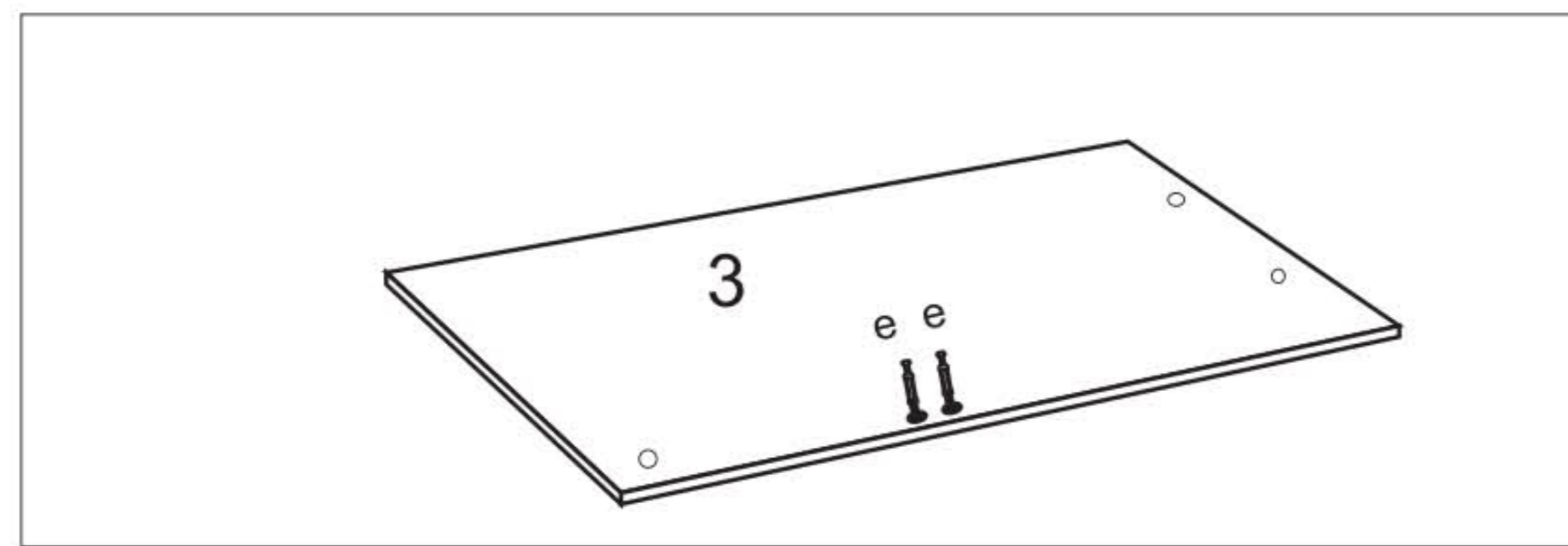
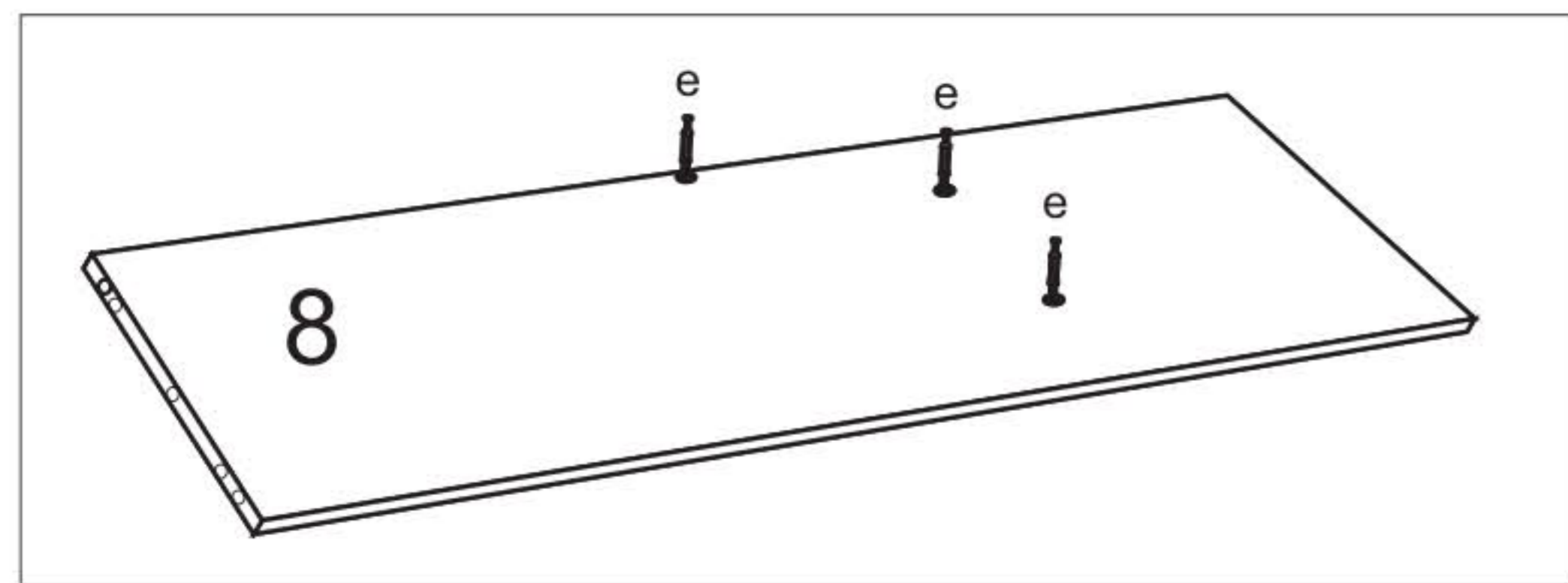
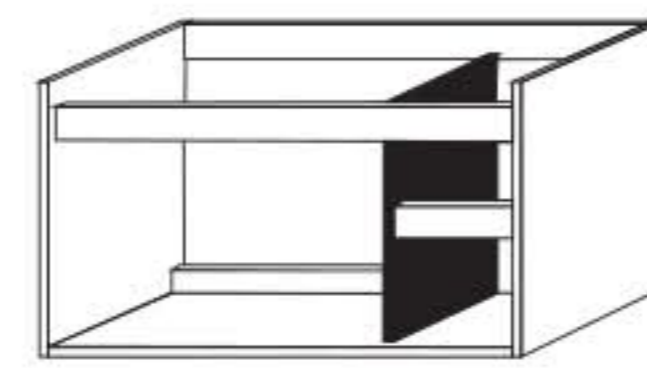
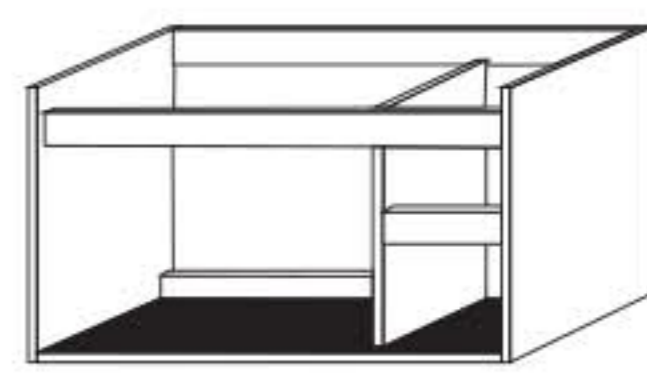
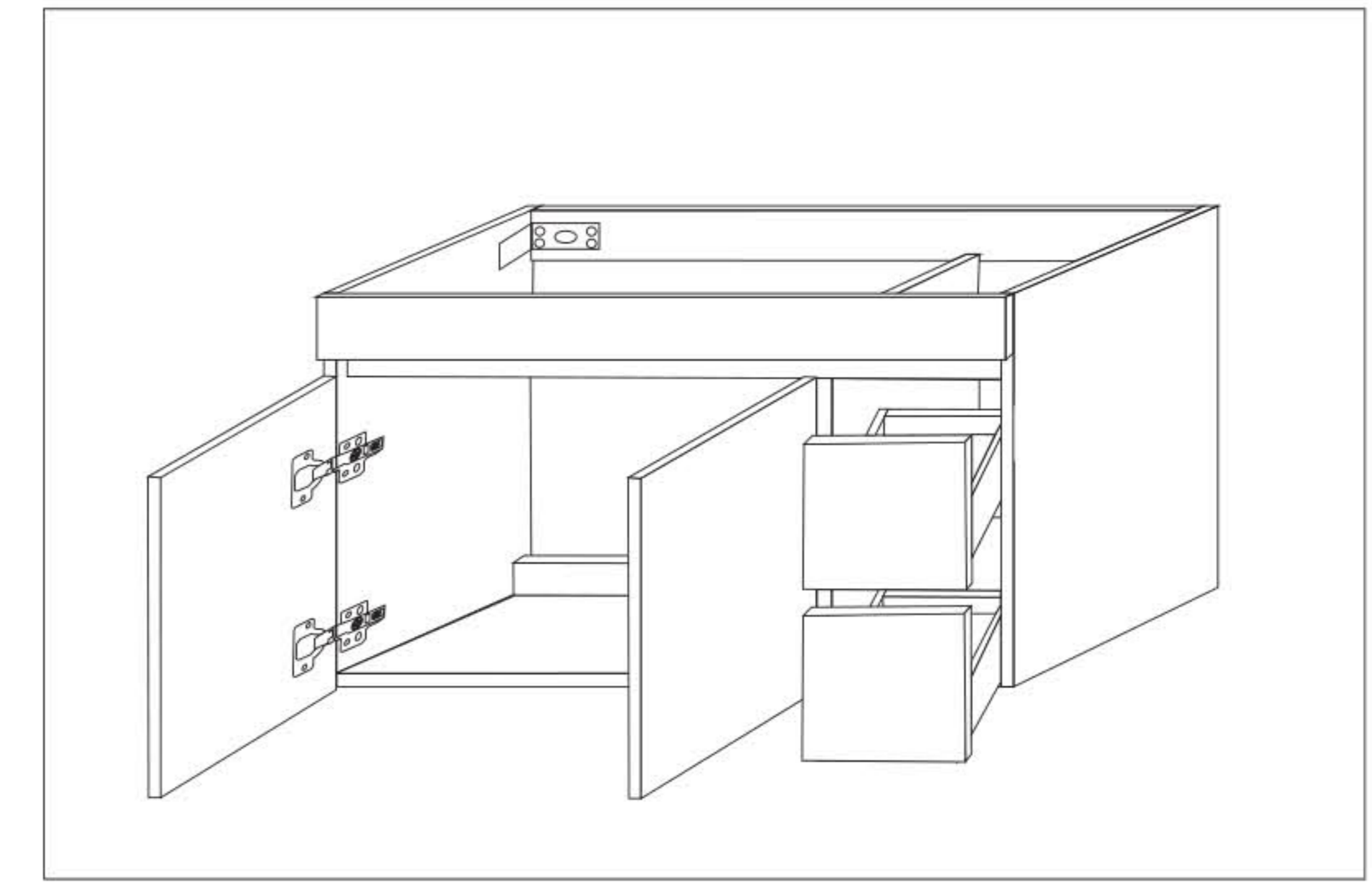
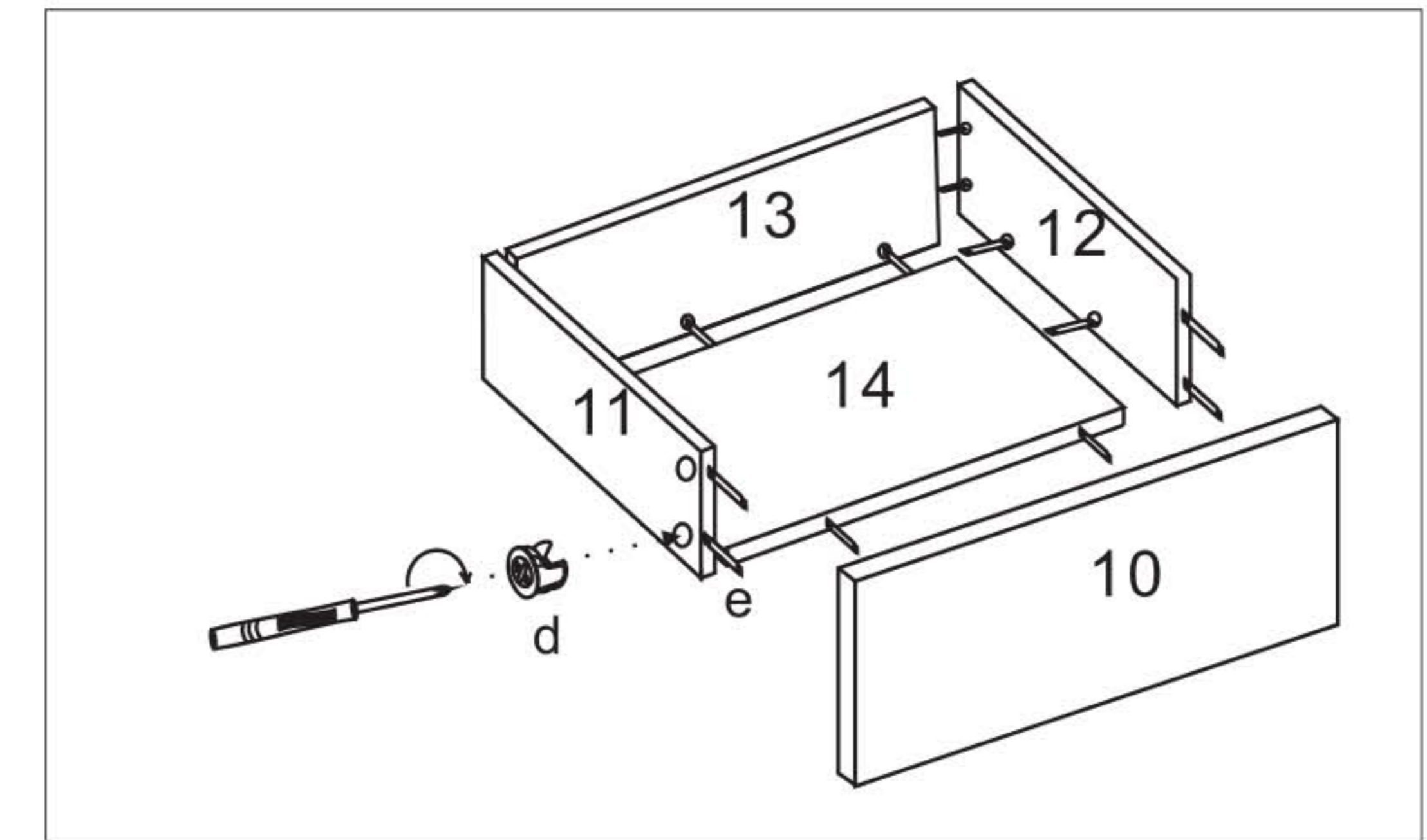
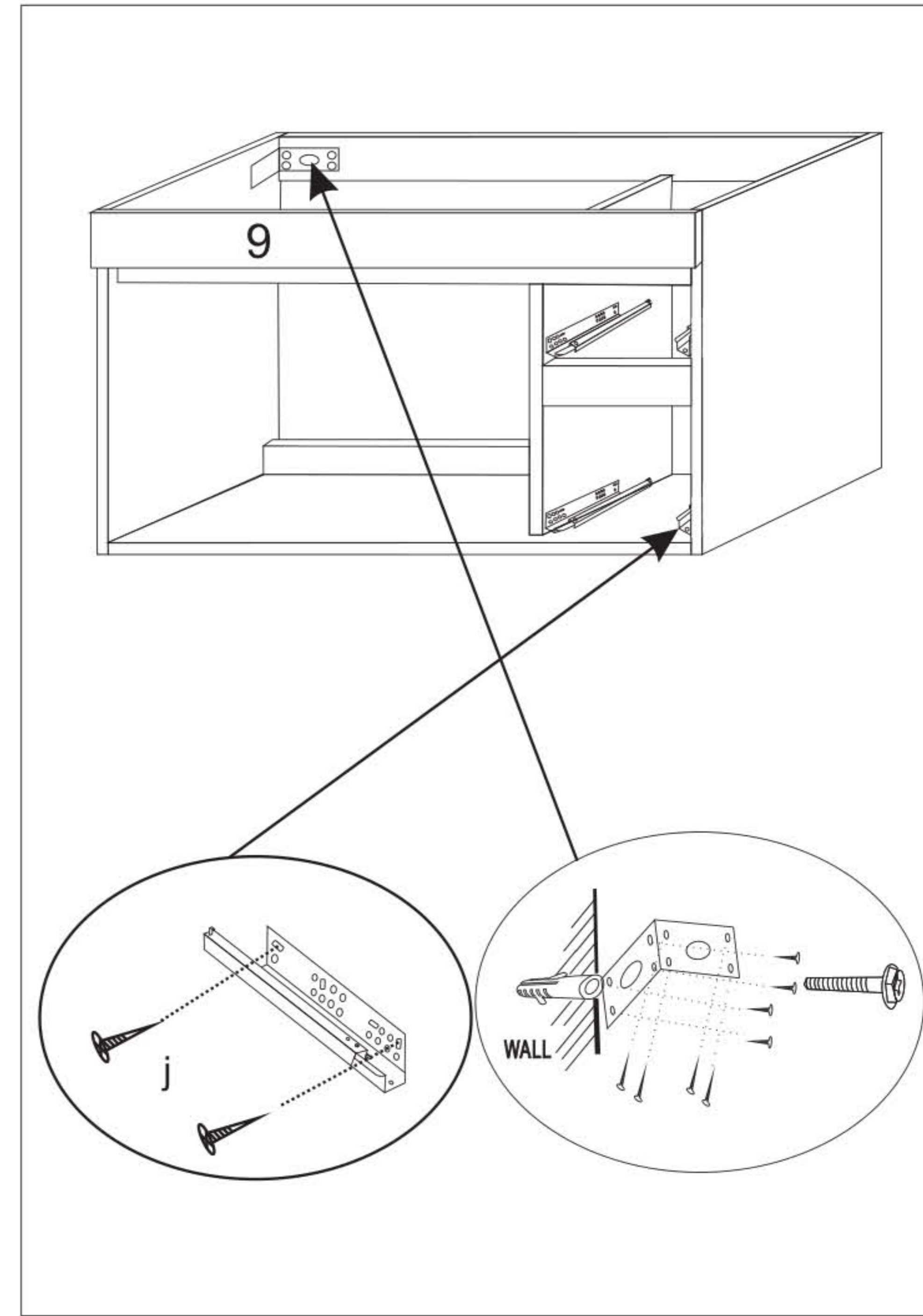
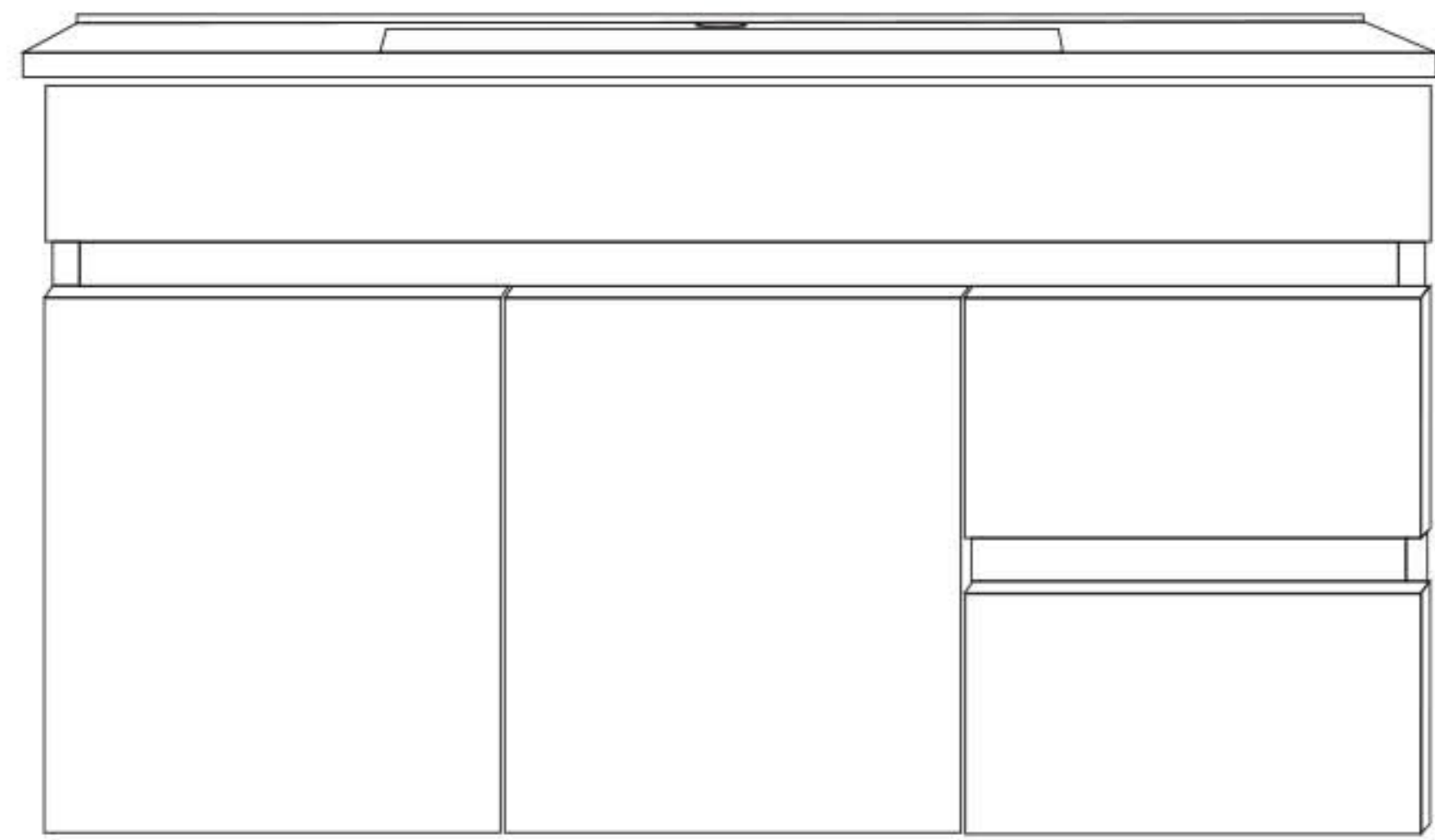

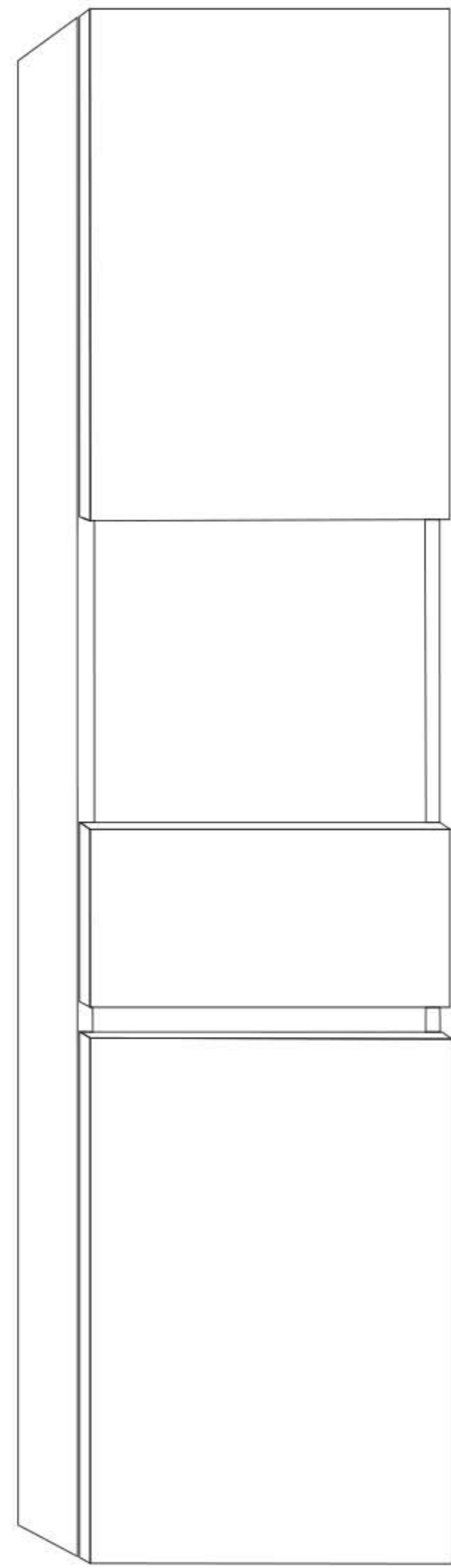

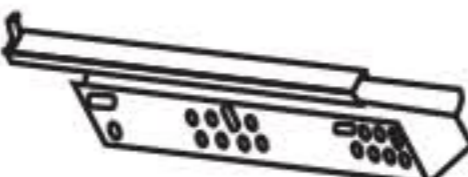

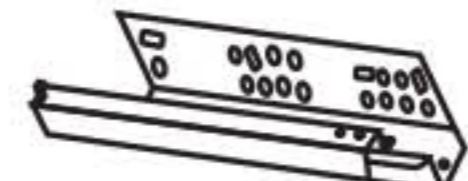





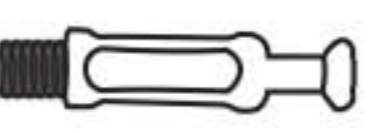

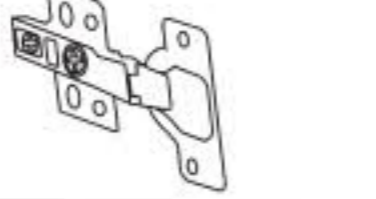
1. Dust regularly with a soft , dry cloth .
2. Avoid the use of all chemicals household cleaners, abrasives, or cleaners that contain lemon, vinegar, or other acids that may damage the finish.
3. Excessive exposure to sunlight and extreme changes in temperature and moisture can damage wood furniture .
4. The sink top is resilient, but care needs to be taken to preserve its appearance.
5. Do not place hot appliances, such as curling irons and hot hair dryers directly on the countertop. Wipe spills immediately.



a	 Left 2x	1	 Left 1x
b	 Right 2x	2	 Right 1x
c	M7*40mm  4x	3	 1x
d	$\Phi 14$  4	4	 1x
e	 5	5	 1x
f	 2x	6	 1x
g	80mm  2x	7	 1x
h	 4x	8	 1x
j	14mm  32x	9	 1x
k	 2x	10	 2x
		11	 Left 2x
		12	 Right 2x
		13	 2x
		14	 2x
		15	 2x

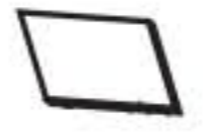

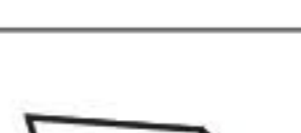

a	 Left 1x	1	 Left 1x
b	 Right 1x	2	 Right 1x
c	M7*40mm 	3	 1x
d	Φ14 	4	 2x
e		5	 4x
f	 4x	6	 1x
g	50mm  4x	7	 1x
h	 4x	8	 1x
j	14mm  32x	9	 1x
		10	 Bottom 1x
		11	 1x
		12	 1x
		13	 1x

